

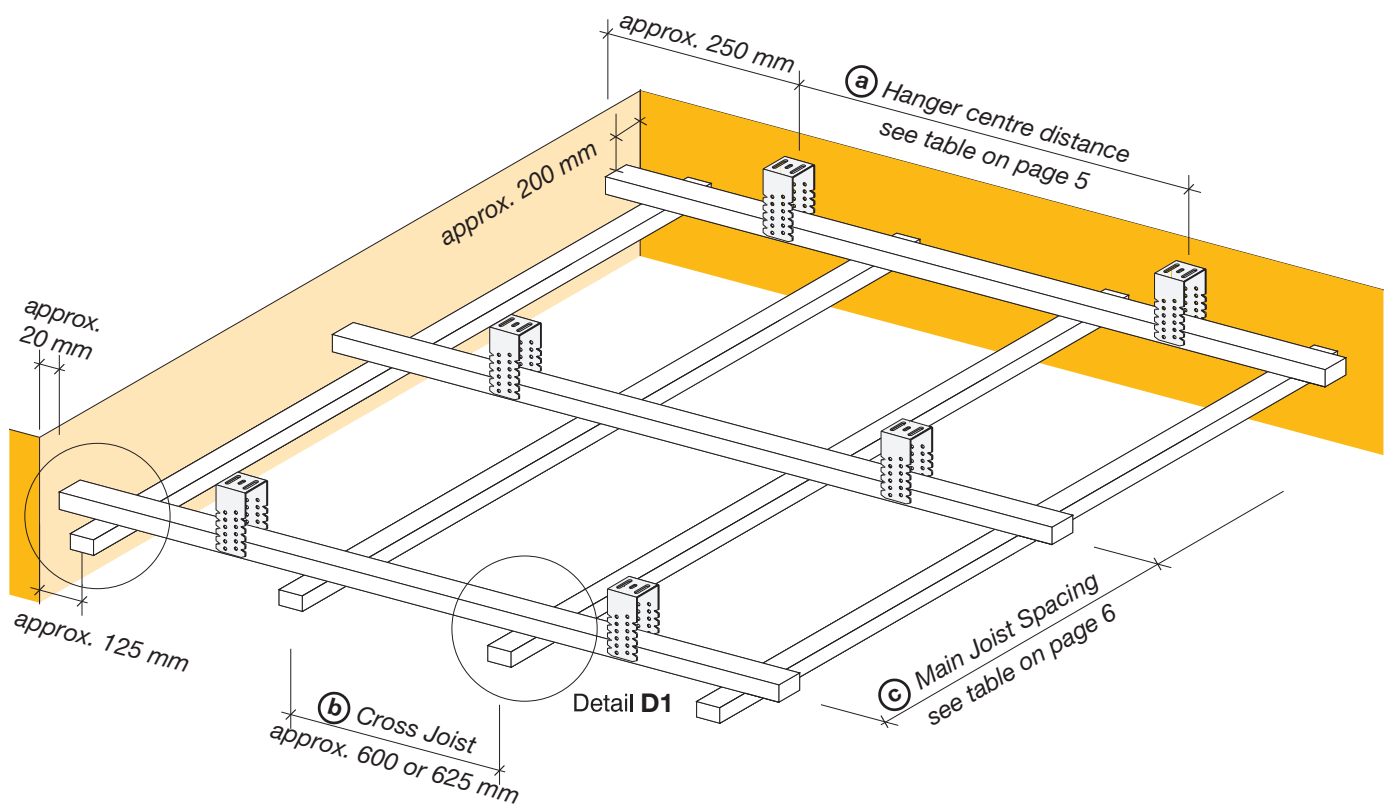

# Fastening onto wood laths



## Products

**Table 1**

	Product	Thickness mm	Weight kg/m <sup>2</sup>	Edge Design <sup>2)</sup>	Centre distance $\text{\textcircled{b}}$ of the cross joist mm	Panel dimensions mm	
Product Range	Heradesign <sup>®</sup> <i>superfine</i>	15	7.8	AK-01	300; 312.5 <sup>1)</sup>	600/600 1200/600 625/625 1250/625	
	Heradesign <sup>®</sup> <i>fine</i>	15	8.2				
	Heradesign <sup>®</sup> <i>superfine</i> <sup>2)</sup>	25 / 35	11.3 / 15.0	AK-01 AK-02 AK-03	600; 625		
	Heradesign <sup>®</sup> <i>fine</i> <sup>2)</sup>	25 / 35	12.4 / 16.3				
	Heradesign <sup>®</sup> <i>micro</i>	25 / 35	15.0 / 19.0				
		Heradesign <sup>®</sup> <i>superfine</i>	35	15.0	VK-12		590; 615
		Heradesign <sup>®</sup> <i>fine</i>	35	16.3			
		Heradesign <sup>®</sup> <i>micro</i>	35	19.0			
Product Range A2	Heradesign <sup>®</sup> <i>superfine A2</i>	15	12.0	AK-01	300; 312.5 <sup>1)</sup>	600/600 1200/600	
	Heradesign <sup>®</sup> <i>fine A2</i>	15	13.0				
	Heradesign <sup>®</sup> <i>superfine A2</i>	25	18.0	AK-01 AK-02 AK-03	600		
	Heradesign <sup>®</sup> <i>fine A2</i>	25	19.0				
Product Range Plus	Heradesign <sup>®</sup> <i>superfine plus</i>	40 (15/25) 50 (25/25)	10.1 13.6	AK-01 plus	600	1200/600	
	Heradesign <sup>®</sup> <i>fine plus</i>	40 (15/25) 50 (25/25)	10.5 14.7				
	Heradesign <sup>®</sup> <i>micro plus</i>	50 (25/25)	17.3				

- 1) For panel dimensions 1200/600 and 1250/625, a centre distance of the laths of  $\frac{1}{3}$  of the panel length is permitted as an alternative. **Panel thickness 15 mm:** not suitable for outdoor applications and indoor swimming pools.
- 2) Please note: edge design GK – straight edge without bevel, for screw installation on wood laths, only carry this out with shadow gaps of  $\geq 4$  mm between the panels. Increased care is necessary during installation. Pay attention to the modified grid dimensions! For edge designs, see pages 53, 54.

**Please note: Knauf Insulation GmbH is not a system holder according to DIN-EN 13964.**

## Detail D1 – Connection main joist/cross joist

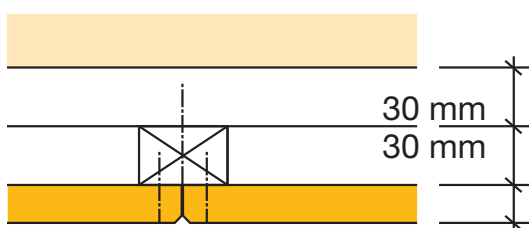

**Fastening of cross joist to main joist** 60/30 or 48/24 with screws  $\geq 4.5 \times 55$  mm as per DIN 7997. Thread engagement min. 25 mm. Number of screws according to static requirements, recommendation: two screws per junction point. As per DIN 18168/T1, however, a single screw is also permitted here ( $\geq 5 \times 55$  mm).

## Maximum spacing of the substructure

For deflection class 1 according to EN 13964 (max. deflection L/500)

Table 2				
Main joists Cross section: w/h 60/30 mm 60/40 mm	Cross joists Max. distance $\textcircled{b}$ 600 or 625 mm	Load classes (dead weight of the suspended ceiling in kN/m <sup>2</sup> )		
		0.15 kN/m <sup>2</sup>	0.20 kN/m <sup>2</sup>	0.30 kN/m <sup>2</sup>
Max. centre distance $\textcircled{c}$	Cross section b/h	Permissible additional load*) in kN/m <sup>2</sup> for hanger spacing $\textcircled{a}$ (m)		
C = 600 mm	60/30	0.30 kN/m <sup>2</sup> a = 1.15 m	0.35 kN/m <sup>2</sup> a = 0.90 m	0.35 kN/m <sup>2</sup> a = 0.75 m
	50/30	0.30 kN/m <sup>2</sup> a = 1.15 m	0.35 kN/m <sup>2</sup> a = 0.90 m	0.35 kN/m <sup>2</sup> a = 0.75 m
C = 800 mm	60/30	0.30 kN/m <sup>2</sup> a = 1.05 m	0.35 kN/m <sup>2</sup> a = 0.80 m	
	50/30	0.20 kN/m <sup>2</sup> a = 1.05 m	0.25 kN/m <sup>2</sup> a = 0.80 m	
C = 1000 mm	60/30	0.30 kN/m <sup>2</sup> a = 0.95 m		
C = 1200 mm	60/30	0.30 kN/m <sup>2</sup> a = 0.90 m		

\*) Additional load: Surface loads of mineral wool lining, suction load from wind, etc. Fittings such as ceiling lights, sprinklers, etc. must be hung separately.

Max. hanger load: 0.40 kN / With a permissible hanger load of 0.25 kN, the additional loads must be multiplied by 0.6, i.e. reduced. Wood quality class S 10 as per EN 1912. For F 30, EI 30 ceilings, or ceilings that are safe against ball throwing, the spacing and cross sections must be according to the test certificate.

## Hangers



Cert. load  $f = 0.15 \text{ kN}$

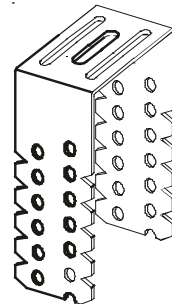

Cert. load  $f = 0.40 \text{ kN}$

## Standard screw pattern for Heradesign® acoustic panels

**Note:** For covered outdoor areas, vibrating constructions, ceilings in indoor swimming pools and for installation of panels that are safe against ball throwing, at least three screws per panel width and support must be used.

### Screw pattern for panel thickness of 15 mm

### Screw pattern for panel thickness of 25 or 35 mm

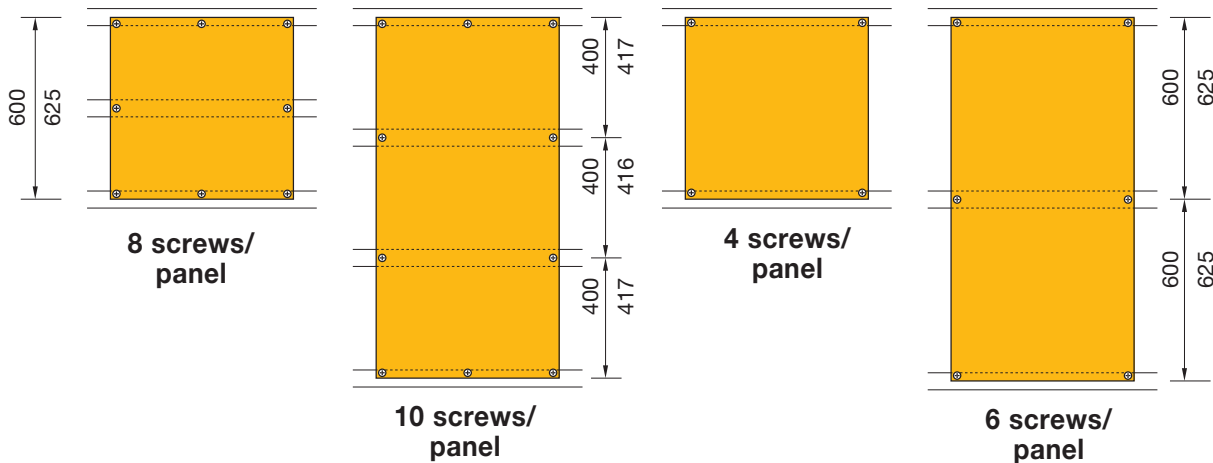

**Note:** Exact marking of the screwing points is carried out by means of the Heradesign drilling template. See page 63, Accessories. Heradesign screw: see page 63.

## Recommended cross sections

Cross joists 60/30 mm or 80/24 mm;  
 minimum cross section: 48 x 24 mm with a main joist  $\geq$  60 x 40 mm

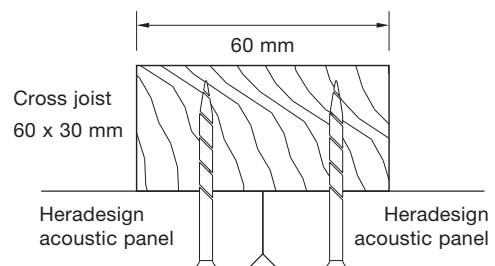
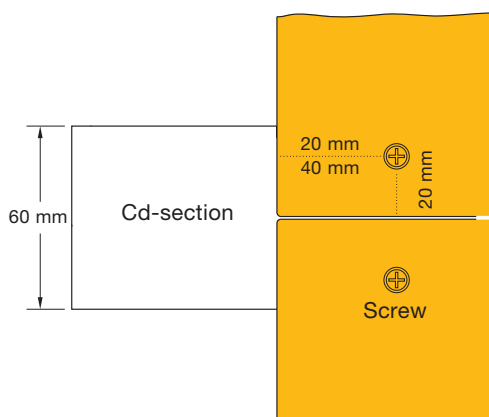

After complete assembly, unpainted screw heads are to be painted.

## Main joists

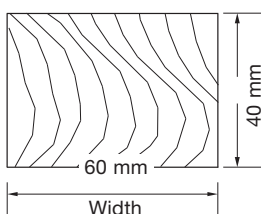

Minimum cross section according to DIN 18168 or EN 13964: 60 x 40 mm or at least 50/30 mm, if main and cross joists have the same cross section.

## Design that is safe against ball throwing according to EN 13964, Annex D, or DIN 18 032/Part 3:

### Screw pattern:

To fasten Heradesign acoustic panels in a way that is safe against ball throwing, at least three screws must be used per panel width and support. Max. spacing of the screws  $\leq 315$  mm.

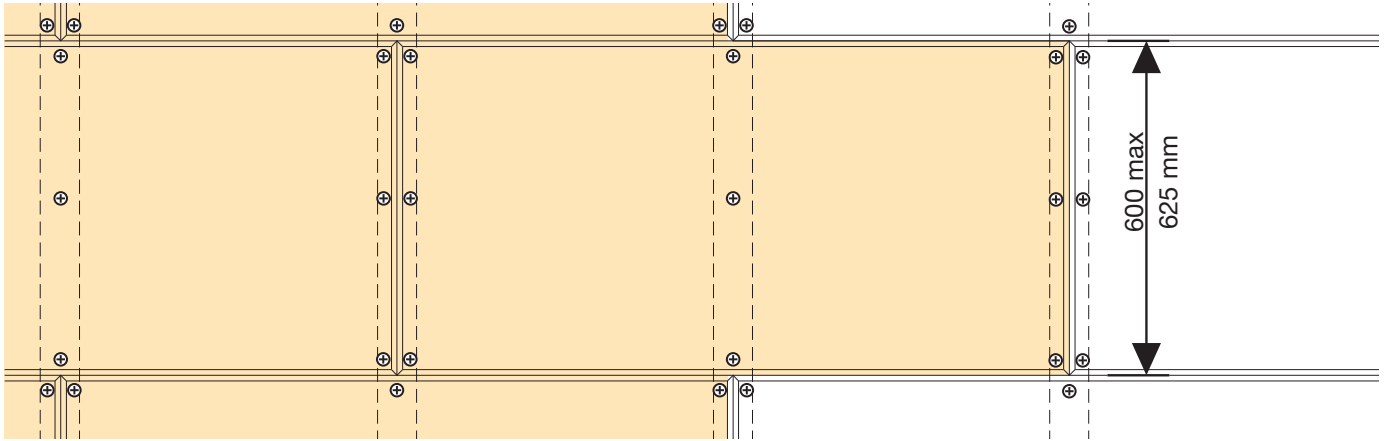

Product	Thickness (mm)	Edge design	Centre distance of cross joists	Dimensioning of main and cross joists	Centre distance *) of main joists and vernier hanger (mm)
Heradesign® <i>superfine</i>	35	AK-01	600; 625	$\geq 60 \times 30$	900
Heradesign® <i>fine</i>	35	AK-01			900
Heradesign® <i>micro</i>	35	AK-01			900

\*) Without additional loads. With additional loads distances according to Table 2 "Maximum spacing of the substructure" for screw mounting onto wood laths, page 6.

\*) Please note: fitting pieces with a length of less than 500 mm must be supported on all four sides.

## Installation of maintenance openings

When installing maintenance openings with dimensions of 400 x 400 mm or 400 x 600 mm in panels with sizes of 1200 x 600 mm or 1250 x 625 mm, the middle lath must be left out over a length of 500 mm so that it is possible to access the ceiling cavity. Pay attention to the additional anchoring for the free ends of the laths. Heradesign maintenance openings are not safe against ball throwing.

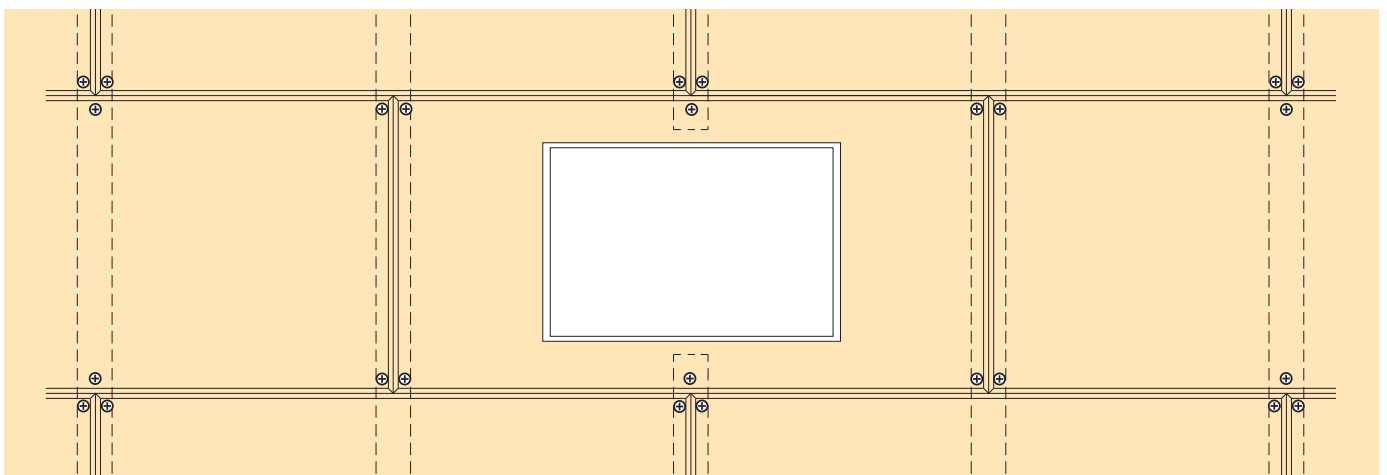

## F 30 ceiling with Heradesign® *fine*, Heradesign® *micro* acoustic panels

Thickness 25 or 35 mm, screwed to wood laths 60 x 40 mm

Certificate: ABP P-3413/9499-MPA BS / Test Institute: iBMB Braunschweig

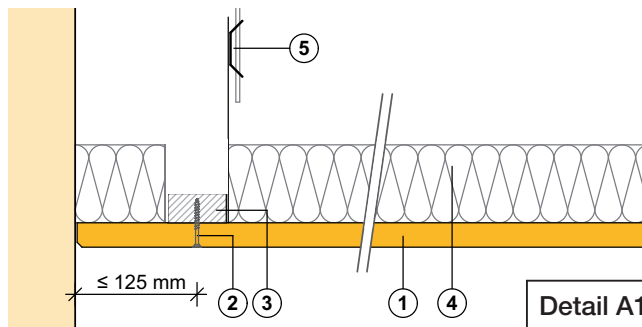

Detail A1 / A2

- 1 Heradesign acoustic panel, 25 or 35 mm
- 2 Drywall screw 4.5 x 50 mm,  
3 screws per panel width, set at an angle of 10°
- 3 Wood lath 60 x 40 mm
- 4 KI DP-5 rock wool, thickness ≥ 80 mm
- 5 Quick hanger with tension spring:  
centre distances max. 630 mm  
edge distances max. 190 mm

## EI 30 ceiling with Heradesign® *micro* acoustic panels

Thickness 25 mm, screwed to wood laths 60 x 30 mm

Edge connection with drywall frieze or butt-jointed

Certificate: 3631/082/10 / Test Institute: iBMB Braunschweig

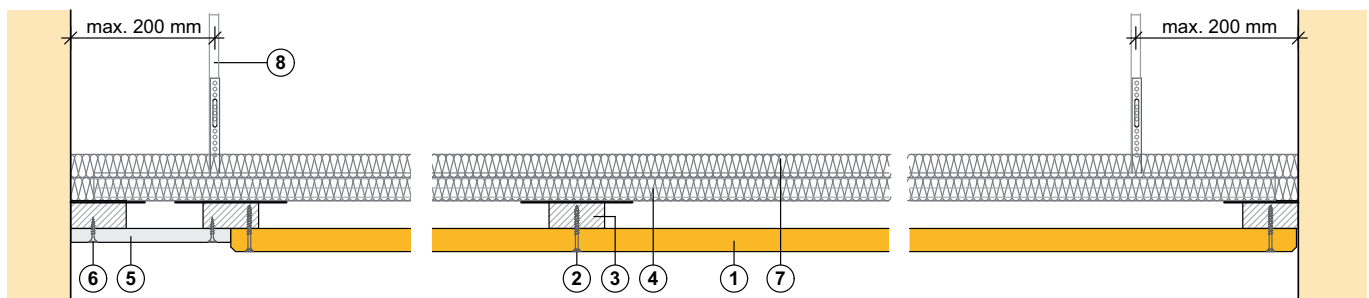

Detail A3 / A4

- 1 Heradesign *micro*, 25 mm
- 2 Heradesign screw 4.5 x 50 mm, three screws per panel width
- 3 Wood lath 60 x 30 mm, cross joist with metal strip 300/30/08  
set out on the upper side every 400 mm
- 4 Wood lath 60 x 30 mm, main joist
- 5 Knauf GFK-A2 panel, 15 mm
- 6 Knauf TN 3.5 x 35 mm screw
- 7 KI DP-9 GS rock wool, thickness 2 x 25 mm
- 8 Vernier hanger, max. distance: 900 mm

## EI 30 ceiling with Heradesign® *superfine A2* acoustic panels

Thickness 25 mm, screwed to wood laths 60 x 30 mm

Edge connection with drywall frieze or butt-jointed

Certificate: 3086/708/09/ Test Institute: iBMB Braunschweig

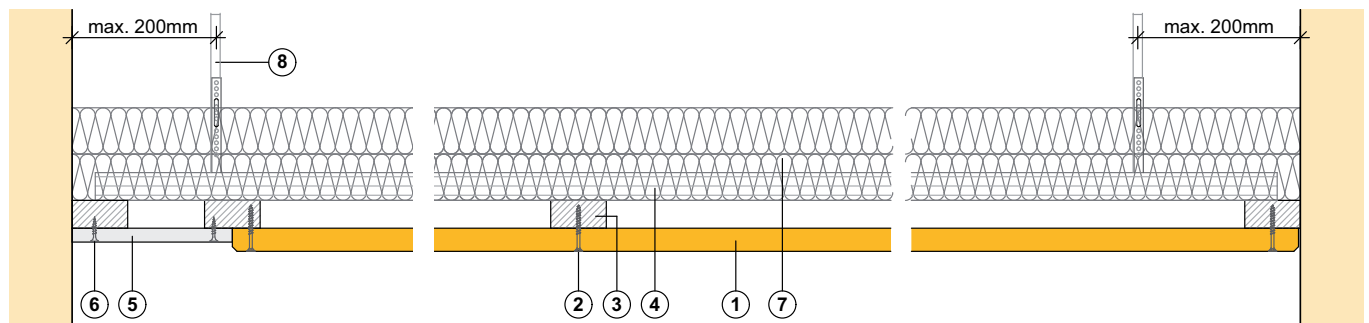

Detail A5 / A6

- 1 Heradesign *superfine A2*, 25 mm
- 2 Heradesign screw 4.5 x 50 mm
- 3 Wood lath 60 x 30 mm, cross joist
- 4 Wood lath 60 x 30 mm, main joist
- 5 Knauf GFK-A2 panel, 15 mm
- 6 Knauf TN 3.5 x 35 mm screw
- 7 KI DP-9 GS rock wool, thickness 2 x 50 mm
- 8 Vernier hanger, max. distance: 900 mm

## EI 30 ceiling with Heradesign® fine A2 acoustic panels

Thickness 25 mm, screwed to wood laths 60 x 30 mm

Edge connection with drywall frieze or butt-jointed

Certificate: 3620/383/09/ Test Institute: iBMB Braunschweig

Detail A7 / A8

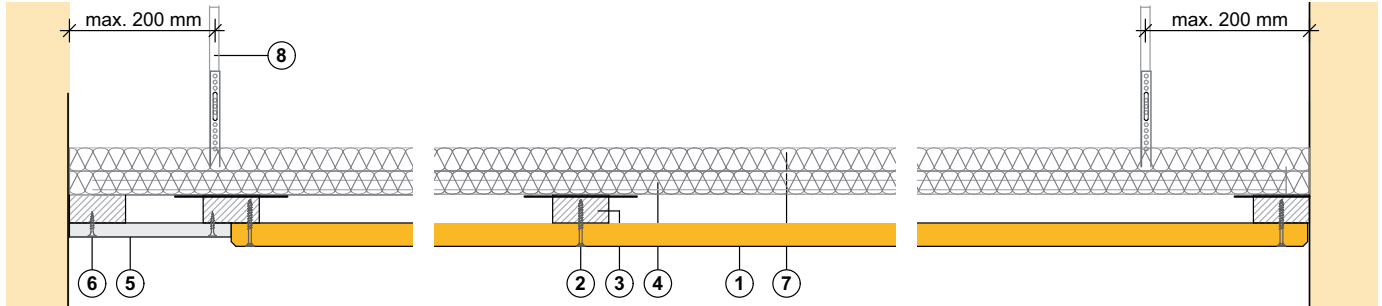

1 Heradesign *fine* A2, 25 mm

2 Heradesign screw 4.5 x 50 mm, 3 screws per panel width

3 Wood lath 60 x 30 mm, cross joist with metal strip 300/30/08 set out horizontally on the upper side every 400 mm

4 Wood lath 60 x 30 mm, main joist

5 Knauf GFK-A2 panel, 15 mm

6 Knauf TN 3.5 x 35 mm screw

7 KI DP-9 GS rock wool, thickness 2 x 25 mm

8 Vernier hanger, max. distance: 900 mm

**Attention:** The classifications only apply to the tested structures. A change in the ceiling structure is not permitted. The exact test assemblies can be found in the indicated certificates or data sheet of the respective design.

## Installation photos

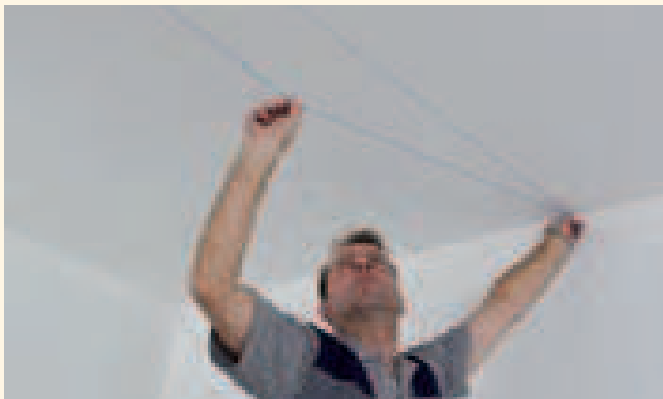

Installing the ceiling grid from the centre of the room, e.g. by using a chalk line. Make sure the margins at the sides of the room are identical.



Aligning the laths with a spirit level or laser level and fastening of the lath to the hanger with two screws each per side.

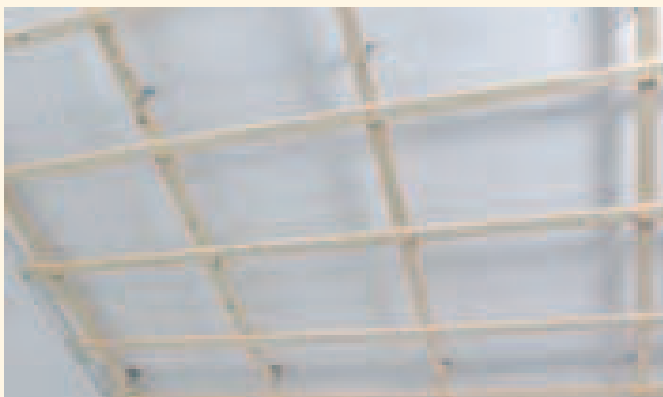

Installation of the main joists and cross joists. Max. distances see Table 2, page 6 and Detail D1, page 5.



Maximum spacing of main and cross joists to the wall, see sketch on page 4.

## Installation photos



Install the acoustic panels by means of supports. Press the panel onto the lath with the ball of the hand while screwing. There must not be a gap between the panel and the wood lath. For larger ceilings, start panel installation from the centre of the room. Observe the installation direction for square panels.

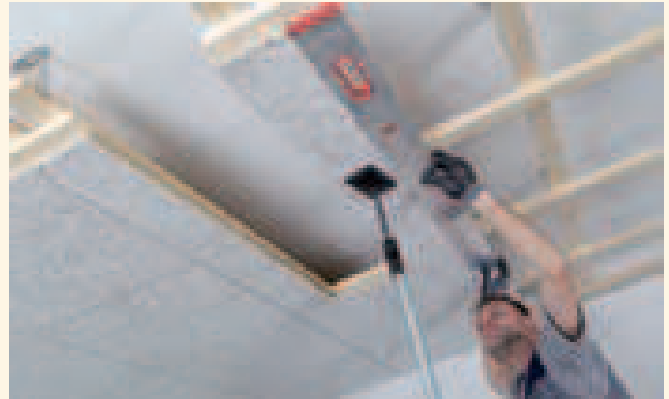

Align the panel rows with an installation lath. Panel joints must be positioned to be centred under the section. No free panel joints are allowed.



Pressure joint potential panel joints with the help of an installation block and hammer. Only work with the acoustic panels with clean hands and clean tools.



Mineral wool absorber panels are inserted piece by piece along with the installation of the Heradesign acoustic panels. Panels that are jammed between the wood laths are cut to size.

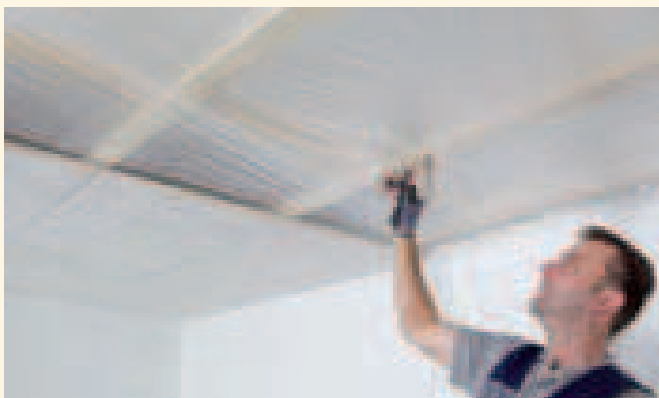

Alternative: insertion of PE sheet as trickle protection or a vapour barrier piece by piece along with the installation of the acoustic panels. Glue sheet joints together.



Paint over the screw heads with the supplied paint or an equivalent. The screw heads must be flush with the surface of the panel.



## Mounting information

- For the implementation **requirements**, also see DIN 18168 T.1 “Lightweight ceiling linings and suspended ceilings”, or alternatively **DIN-EN 13964** “Suspended ceilings – requirements and test methods”.
  - Before you start mounting, check the base for sufficient load-bearing capacity.
  - Fasten wood laths to the ceiling or the pre-installed hangers at the required centre distance with rust-protected screws.
  - Distribute laths symmetrically (equal edge fields).
  - Start panel installation for larger ceilings from the centre of the room.
  - Press the panels in and align them longitudinally in the bracing, transversely to the direction of the laths and fasten them with rust-protected drywall screws (DIN 7997) (head diameter  $\geq 9$  mm) to the laths. For each panel width and centre distance, two drywall screws are required. For covered outdoor areas, ceilings and walls in indoor swimming pools, vibrating constructions and for the version that is safe against ball throwing, three drywall screws (DIN 7997) are required.
- Please note:** observe the necessary corrosion protection requirements.
- **Cross joints:** four panel corners meet at one point, which means increased accuracy is required when installing.
  - **For F 30 constructions as per DIN:** set the screws at an angle of 10 degrees or use washers.
  - **Screws:** Wood or drywall screws with partial thread and countersunk heads are suitable. Head diameter  $\geq 9$  mm). The necessary corrosion protection must be matched to the conditions prevailing in the room. The screw heads must be set to be flush with the panel surface. After installation, unpainted screw heads must be covered with a paint supplied by the manufacturer or an equivalent.
  - **Film** or mineral wool is inserted piece by piece with the installation of the acoustic panels. Film joints and connections must be taped up. A PE film with a thickness of up to 30  $\mu\text{m}$  does not degrade the sound absorption of the underlying absorbers and is recommended as trickle protection for mineral wool lining.
  - **Damaged** or soiled panels or panels with colour deviations may not be installed.
  - Panels with edge design SK-04 may not be installed because the panel size is smaller than the grid dimensions.

- **Square panels:** observe the installation direction marked on the back when installing the panels.

Facing panel	see page 42
Light installation details	58
Processing	68
Please request expert opinion if required.	

## Heradesign® screw

Rust-protected, universal drywall screw for attaching Heradesign acoustic panels to laths and CD-sections 60/27/06 mm. Partial thread, screw head with Torx T20, see page 63.

**Maximum spacing:** 600 or 300 mm / 625 or 312 mm, see page 7.

**Please note:** not suitable for indoor swimming pools and outdoor applications.

Panel size	Screws required approx. pieces / m <sup>2</sup>			
	600/600	625/625	1200/600	1250/625
Standard screw pattern – panel thickness 25 and 35 mm	12	11	9	8
Standard screw pattern – panel thickness 15 mm	23	21	14	13
Design that is safe against ball throwing	17	16	13	12

**Table 5 – Delivery form of Heradesign® screws**

Dimensions mm		Colour of screw head	For panel thickness mm	Packaging unit pieces/box
Length	Ø			
35	4.5	--	15	200
50	4.5	--	25	200
50	4.5	weiß / natur	25	200
60	4.5	--	35	200

**Corrosion protection:** to find suitable corrosion protection for screws for applications in indoor swimming pools, underground garages, covered outdoor applications or other special applications, please contact your screw supplier or screw manufacturer.

**Table 6**

Panel thickness (mm)	15	25	35
Screw dimensions according to DIN 7997, ÖNORM M5027 (mm)	4.5/35	4.5/45	4.5/60

## Notes